

ATB MOTOR CATALOG

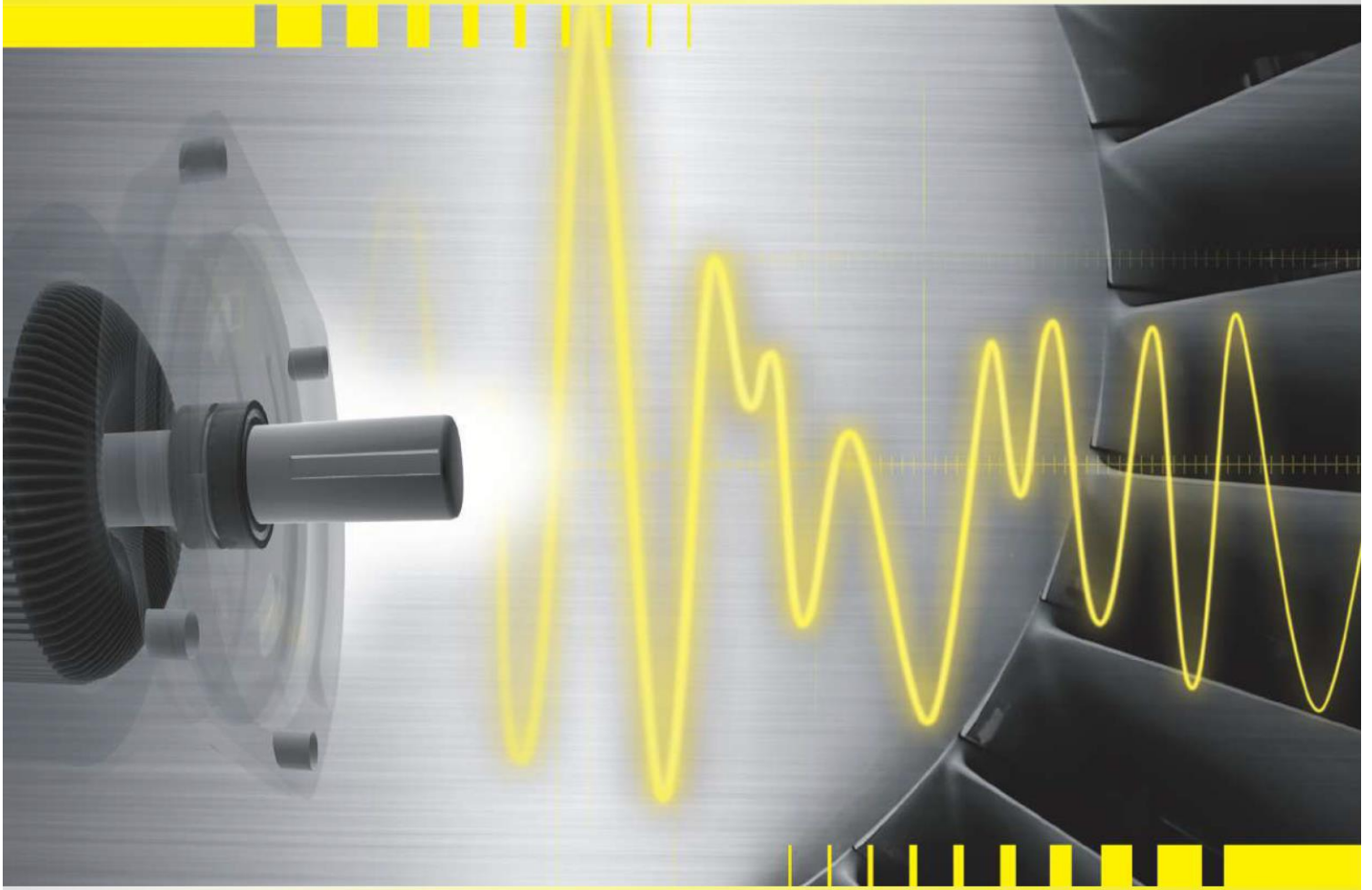

WE Series

IE2

Low-Voltage High Power Three Phase Asynchronous Motor

ATB History

About ATB

The history of ATB Group dates back more than 100 years. Originated in 1919 as electro-technical workshop and started production of electric motors in Stuttgart, Germany.

Today, the head office of ATB Group is located in Austria. The Group ranks among the leading global suppliers of electric drive systems for industrial applications and home appliances.

The ATB Group product range extends from 25W to 25MW and includes standard solutions, customised solutions and design-to-order solutions including complete drive systems for a wide range of applications.

The ATB Group, which includes famous brands such as Schorch, Morley, Laurence & Scott, currently has worldwide manufacturing bases - in Germany, United Kingdom, Austria, Poland, Serbia, China and Vietnam.

ATB History 1919 - Present

- 1919 Gottlob Bauknecht sets up an electro-technical workshop
- 1930 Production of electric motors starts in Stuttgart
- 1932 Gottlob Bauknecht builds a fully sealed electric motor which becomes the prototype for many generations of electric motor
- 1938 Welzheim plant is acquired and manufacture of electric motors established
- 1974 The newly constructed small-size motor factory, with a production area of 36,000 m², is commissioned in Spielberg, Austria
- 1976 The Spielberg motor factory produces its millionth electric motor. The company's founder, Gottlob Bauknecht, dies and his sons Guenter and Gerhard Bauknecht carry on with the management of the company
- 1986 ATB shares are listed on the Frankfurt and Stuttgart stock exchange
- 2012 Company name change of ATB Motorentechnik GmbH, Nordenham and Schorch Elektrische Maschinen und Antriebe GmbH, to: ATB Nordenham GmbH, ATB Schorch GmbH
- 2012 130th anniversary of SCHORCH 
- 2019 100th anniversary of ATB



Full Range Supplier



Applications

- Propulsion
- Winches
- Conveyor Technique
- Heavy Lifting Systems
- Lift Drives
- Compressors
- Pumps
- Agitators
- Extruders
- Mills
- Rolling Mills
- Shredders
- Mining Machinery
- Traction Drives
- Auxiliary Drives
- Machine Tools
- Printing Machines
- Textile Machines
- Test Stands
- Injection Moulding Machines
- High Pressure Cleaners
- Lawn Mowers
- Scarifiers
- Chaff Cutters
- Concrete Mixers
- Ventilators/Blowers

ATB Brands

ATB LAURENCE
SCOTT

ATB Laurence & Scott

*Production: ATB Laurence Scott Ltd.
Established: 1883
Location: Norwich (United Kingdom)*



ATB MORLEY

ATB Morley

*Production: ATB Morley Ltd.
Established: 1897
Location: Leeds (United Kingdom)*



ATB SEVER

ATB Sever

*Production: ATB Sever
Established: 1923
Location: Subotica (Serbia)*



ATB NORDENHAM
Technology in Motion
SCHORCH

ATB Nordenham GmbH

*Production: ATB Nordenham GmbH
Established: 1952
Location: Nordenham (Germany)*



Tamel
ELECTRIC MOTORS

ATB Tamel S.A.

*Production: ATB Tamel S.A.
Established: 1949
Location: Tarnow (Poland)*



SCHORCH

ATB Schorch GmbH

*Production: ATB Schorch GmbH
Established: 1882
Location: Moenchengladbach (Germany)*





LV IEC motors

Type of protection: Safe Area
 Power range: 0.06kW to 4800kW
 Frame size: 56 - 710
 Number of poles: 2, 4, 6, 8 and more
 Efficiency Class: IE2, IE3, IE4
 Applications:
 Water and vacuum pumps, fans, compressors, drive systems, chemical industry, marine, etc.

LV NEMA motors

Type of protection: Safe Area
 Frame size: 56 - 586
 Number of poles: 2, 4, 6, 8 and more
 Applications:
 Water and vacuum pumps, fans, compressors, drive systems, chemical industry, marine, etc.



LV Motors for hazardous atmospheres

Type of protection: Ex ec, Ex eb, Ex db eb, Ex db
 Power range: 0.06kW to 2000kW
 Frame size: 63-560
 Number of poles: 2, 4, 6, 8 and more
 Efficiency Class: IE2, IE3, IE4
 Applications:
 Oil & gas industry, petrochemical industry, wood industry, pumps, fans, compressors, etc.

Smoke extraction motors

Type of protection: Safe Area - 200C, 400C, 600C
 Power range: up to 1000 kW
 Frame size: 80-500
 Number of poles: 4
 Applications:
 Stairwells, shopping malls, public buildings, tunnels, industrial buildings, enclosed car parks, etc.



Home appliance motors

Type of protection: Safe Area
 Power range: 0.01kW to 5.5kW
 Frame size: 45 - 112
 Number of poles: 4
 Applications:
 All types of industrial uses, e.g. pump drives, fans and grain mills, lawn mowers, chopping machines, lawn aerators, concrete mixer, etc.



LV&HV Slip ring motors

Type of protection: Safe Area

Power range: LV up to 11 00kW, HV up to 13.2 MW

Frame size: LV 160-560 , HV 355 to 1120

Number of poles: 2, 4, 6, 8 and more

Applications:

Marine motors, bow thruster drives, compressors for ship industry, Heavy duty pumps, conveyor belt, stone crusher, heavy duty cranes, etc.

HV Motors for hazardous atmospheres

Type of protection: Ex ec, Ex eb, Ex db eb, Ex db

Power range: up to 25 MW

Frame size: up to 1700

Number of poles: 2, 4, 6 and more

Applications:

Mining, oil & gas industry, marine, petrochemical industry, etc.

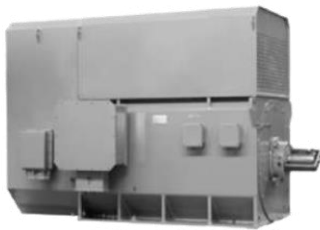

HV Synchronous & Asynchronous motors

Type of protection: Safe Area, Hazardous Area

Power range: Up to 25 MW

Frame size: 225 - 1000 and above

Number of poles: 2, 4, 6, 8 and more

Efficiency Class: IE2, IE3, IE4

Applications:

Conveyor technology, water pump, power generations, compressor, pump drives, shredder, shipbuilding, wood/paper industry, mining, nuclear power generation, oil & gas industry, etc.

HV Synchronous & Asynchronous generators

Type of protection: Safe Area

Power range: up to 10 MW

Frame size:

- Synchronous up to 1700

- Asynchronous up to 1000

Number of poles:

- Synchronous up to 17000

- Asynchronous 2,4,6,8 and more

Applications: Hydro power plants



Quality assurance

The entire order realisation process for electrical machines, from quotation to delivery including the integration of our suppliers, is based on a generally accepted quality assurance system pursuant to ISO 9001, which is constantly monitored and undergoes further development.

The designs, technical data and illustrations contained in this documentation are subject to change.

They are only binding upon written confirmation.

Standards, codes, regulations and specifications

The motors conform to the relevant standards and regulations, including without limitation the following:

Title	IEC	DIN/EN	GB
Rotating electrical machines Rating and performance	IEC 60034-1	DIN EN 60034-1	GB 755
Determination of losses and efficiency	IEC 60034-2-1	DIN EN 60034-2-1	GB/T1032
IP degrees of protection	IEC 60034-5	DIN EN 60034-5	GB/T 4942.1
Methods of cooling (IC code)	IEC 60034-6	DIN EN 60034-6	GB/T 1993
Types of construction (IM code)	IEC 60034-7	DIN EN 60034-7	GB/T 997
Terminal markings and direction of rotation	IEC 60034-8	DIN EN 60034-8	GB 1971
Noise limits	IEC 60034-9	DIN EN 60034-9	GB 10069.3
Built-in thermal protection; rules for protection	IEC 60034-11	DIN EN 60034-11	GB/T 13002
Starting performance of single-speed three-phase cage induction motors, excluding multi-speed motors, for voltages up to and including 690 V/50 Hz	IEC 60034-12	DIN EN 60034-12	GB/T 22210
Mechanical vibration of certain machines with shaft heights of 56 mm and above	IEC 60034-14	DIN EN 60034-14	GB10068
Rotating electrical machines - Part 25: Guidance for the design and performance of cage induction motors designed for converter supply	IEC 60034-25	DIN EN 60034-25	
Efficiency classes of three-phase squirrel cage motors	IEC 60034-30-1	DIN EN 60034-30-1	GB18613
IEC standard voltages	IEC 60038	DIN IEC 60038	
Three-phase motors for general use with standardized dimensions and outputs	IEC 60072 ¹⁾	DIN EN 50347	GB/T 4772.1

¹⁾ IEC 60072 only provides for dimensions but does not define any output classifications. (tolerances acc. to EN 50347)

Nomenclature



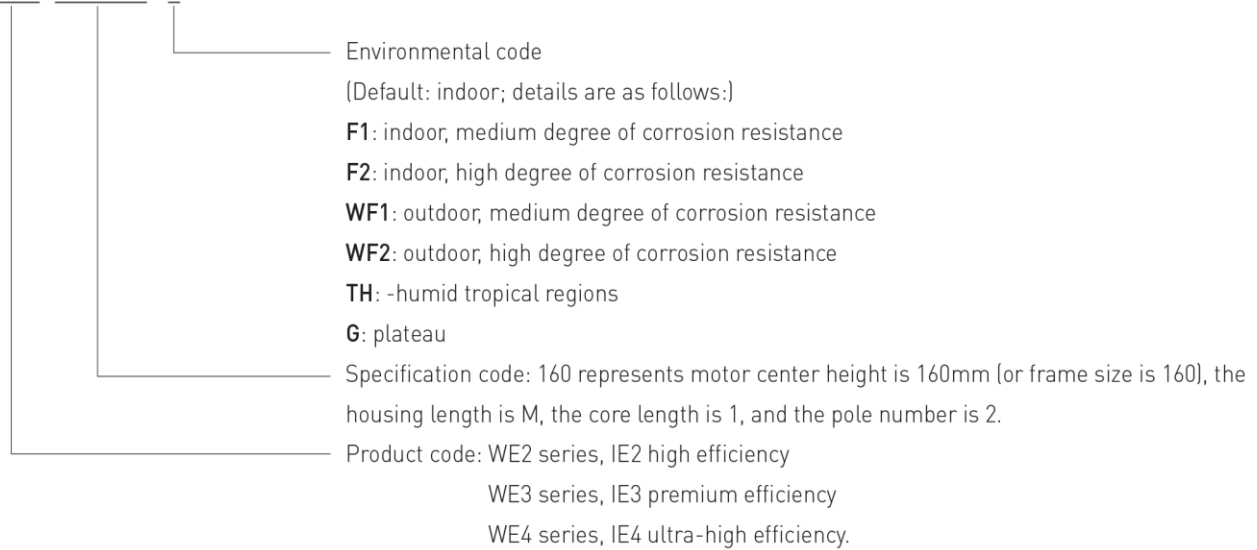



WE2 160 M1-2 - X











Specification

Specification	Standard product	Option
Frame size	80~355	-
Rated power	0.18~375kW	-
Number of poles	2P, 4P, 6P, 8P	-
Rated voltage	380V	On request
Frequency	50Hz	60 Hz
Duty	S1	S2, S3
Efficiency level	IE2, IE3, IE4	-
Mounting option	B3, B5, B35	B14, B34
Insulation	Class F	Class H
Connection	Below 4kW: "Y" connection 4kW or above: "Δ" connection	-
Thermal protection	-	Thermistors, Thermostats or RTDs
Anti-Condensation heaters	-	110V or 220 to 240V
Enclosure	IP55	IP56, IP65
Cooling type	IC411	IC416, IC418
Frame material	Aluminium: 90 to 160 Cast iron : 80 to 355	-
Terminal box position	Top	Right hand side, left hand side
Located bearing	Drive end	-
Lubrication	80 to 180 Sealed for life bearings 200 to 355 Regreasing	160 to 180 Regreasing -
Inverter Duty (with derate)	Variable Torque: 10:1 Constant Torque: 2:1	- Alternative speed range
Ambient temperature	-20°C~+40°C	-
Altitude	No more than 1000 m	On request

Mounting arrangements

Basic structural type	With foot, endshield without flange					
Mounting type code	B3	B6	B7	B8	V5	V6
Schematic diagram						
Frame	H80-H355		H80-H160			

Basic structural type	Without foot, endshield with flange			With foot, endshield with flange		
Mounting type code	B5	V1	V3	B35	V15	V36
Schematic diagram						
Frame	H80-H280	H80-H355	H80-H160	H80-H355	H80-H160	

Basic structural type	Without foot, endshield with a small flange		With foot, endshield with a small flange	
Mounting type code	B14	V18	B34	
Schematic diagram				
Frame	H80-H112			

Level of protection

WE series standard protection grade is IP55, IP56, IP65, IP66 and other protection grades can be customized according to customer requirements.

The protection level of the shell is mainly to prevent electric shock to human body or close to live parts or rotating parts, to prevent solid foreign matter from entering and to prevent harmful effects caused by water and oil. The code name and meaning of the protection form is shown in the table below.

Code	Meaning	First digit	Meaning	Second-order digit	Meaning
IP	Level of protection	5	Dust prevention	5	Prevent water spray
		6	Dust tight	6	Prevent strong spraying of water

Insulation grade and temperature rise limit

WE series adopts F grade insulation, and the temperature rise is assessed as B grade. Nano-insulation impregnating resin can be selected to further improve the service life in the power supply environment and service environment.

In order to run the motor reliably, insulation materials are needed to separate the live parts from the enclosure or live parts. Motor as an energy conversion or signal conversion element. There is energy loss in the process of operation itself, a portion of the energy losses caused by temperature rise from itself. Under the general condition, insulation class, suffering the most from extreme temperatures and the resistance method is used to measure the motor temperature rise limit between comply with the following table, the temperature rise limit within the motor should be able to work properly.

Insulation grade	Limited temperature°C	The temperature rise limit K
B	130	80
F	155	105
H	180	125

Nameplate sample

		3~AC MOTOR		IE2	
		CE			
	kW	Hz	Conn.	No.	
V	%	COS φ	IP	DE	
A	SF	r/min	Th.Cl.	NDE	
	S1	kg	dB(A)	DATE	



Terminal box

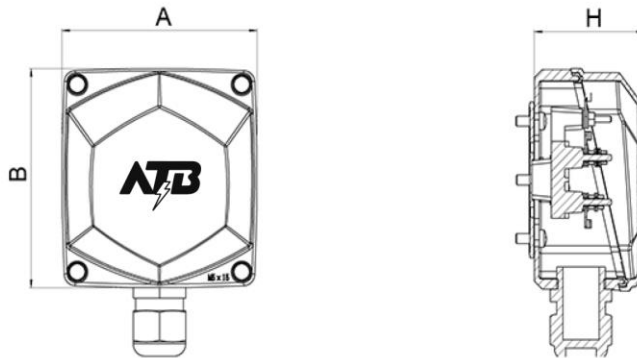

Frame	Boundary dimension AxBxH (mm)	Number and size of outlets	Diameter of single hole screw sleeve can lock the cable (mm)	Thread of terminal
H80	90x96x50	1-M25x1.5	Ø8-Ø12	M4
H90-H100	102x110x57.5	1-M25x1.5	Ø8-Ø12	M4
H112-H132	136x146x72	2-M25x1.5	Ø8-Ø12	M5
H160-H180	171x181x91	2-M32x1.5	Ø16-Ø21	M6
H200-H225	220x230x113	2-M50x1.5	Ø32-Ø39	M8
H250-H280	270x280x162	2-M63x1.5	Ø37-Ø44	M10
H315	312x329x175	2-M63x1.5	Ø37-Ø44	M12
H355	382x402x200	2-M72x2	Ø45-Ø53	M16

Lifting ring

Frame	Lifting ring	Horizontal mounting	
		Quantity	Location
H80-H90S	---	---	---
H90L-H112	M8	1	Top
H132	M10	1	
H160	M12	1	
H180	M16	1	Top, both sides of terminal box
H200-H225	M20	2	
H250-H280	M24	2	Left front and right rear view from shaft end
H315	M30	2	
H355	M36	2	

Bearing type for aluminum motor

Frame	Poles	DE	NDE
H90	2-6	6205ZZ	6203ZZ
H100	2-6	6206ZZ	6205ZZ
H112	2-6	6206ZZ	6206ZZ
H132	2-6	6208ZZ	6208ZZ
H160	2-6	6309ZZ	6309ZZ

Bearing type for cast iron motor(WE2)

Frame	Poles	DE	NDE	Frame	Poles	DE	NDE
H80	2-8	6204ZZ	6204ZZ	H225	4-8	6313	6312
H90	2-8	6205ZZ	6203ZZ	H250	2	6313	6313
H100	2-8	6206ZZ	6205ZZ	H250	4-8	6314	6313
H112	2-8	6206ZZ	6206ZZ	H280	2	6314	6314
H132	2-8	6208ZZ	6305ZZ	H280	4-8	6317	6314
H160	2-8	6309ZZ	6307ZZ	H315	2	6317	6317
H180	2-8	6310ZZ	6308ZZ	H315	4-8	6319	6319
H200	2-8	6312	6212	H355	2	6319	6319
H225	2	6312	6312	H355	4-8	6322	6322

Note:ZZ - Double shielded bearings.

The table above shows standard bearing sizes, alternative bearings are available if required.

Permissible forces at the shaft end

Maximum radial force (for pulley drive system): The maximum allowable radial force F_0 (unit: N) for radial load is based on the premise that the load line (center of pulley) must be within the length of the motor shaft extension (the motor shaft elongation is shown in the installation size code E size). The radial force length X (mm) is the distance from the axial extension shoulder to the radial force F_0 action line, so when the length $X = \text{Max}$, it is the total length of the axial extension (size value E). Maximum allowable radial force as below table.

Frame	Radial force F_0 [N]							
	2P		4P		6P		8P	
	X=0	X=max	X=0	X=max	X=0	X=max	X=0	X=max
H80	720	600	760	630	860	720	980	820
H90	780	650	810	670	940	780	1060	880
H100	1100	900	1110	910	1310	1070	1480	1210
H112	1090	900	1080	890	1290	1060	1460	1200
H132	1730	1360	1740	1400	2000	1610	2330	1880
H160	2950	2330	3050	2410	3420	2700	3870	3060
H180	3420	2740	3460	2820	4080	3320	4430	3610
H200	4390	3640	4500	3730	5270	4370	5790	4800
H225	4340	3620	5050	4030	5870	4690	6470	5170
H250	4910	4000	5710	4650	6520	5310	7180	5840
H280	5380	4500	6870	5750	8090	6770	9120	7630
H315	6400	5550	7500	6310	8420	7080	9120	7670
H355	6770	6070	8620	7560	9910	8690	11590	10160

Permissible radial force Frame sizes 80-355

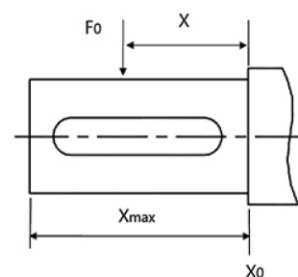

Thermal protection device is optional for WE series.

Thermistor PTC

Name	PTC thermistor
Type	MZ6 160 D
Application	Motor overheating protection
Operating temperature and accuracy	160 ±5°C
Set position	1 in each phase, in series, at the highest temperature point embedded at the end of the winding at the drive end
Connection	Three components in series, two leads to the terminal box.
Color and marking of wiring	P1 & P2
Wiring diagram	
Frame	80 to 355

Note : (1) PTC operating temperature can be customized according to specifications
 (2) PTO thermosensitive bimetal switch can be used according to specifications.

Winding Resistant Temperature Detector (RTD)

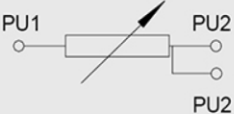
Name	Platinum Resistant Temperature Detector (RTD)
Type	PT100, three leads
Application	Motor winding temperature detection, high temperature protection
0°C resistance and precision	100± 0.12Ω (Class B tolerances)
Set position	1 in each phase, at the highest temperature point embedded at the end of the winding at the drive end
Connection	Each component has three lead wires to the terminal box
Lead Markings	U – PU1, PU2, PU2 ; V– PVI, PV2, PV2; W– PW1, PW2, PW2. If there are two elements in each phase winding, the lead of the other element is marked as: U– PU3, PU4 , PU4 ; V– PV3, PV4, PV4 ; W– PW3, PW4, PW4
Wiring diagram	
Frame	160 to 355

Bearing Resistant Temperature Detector (RTD)

Name	Platinum Resistant Temperature Detector (RTD)
Type	WZP-M, three leads, sealed metal body
Application	Motor winding temperature detection, over temperature protection
0°C resistance and precision	100± 0.12Ω (Class B tolerances)
Quantity	One per bearing
Set position	Embedded inside the endshield, the face of the sensor must contact the outer ring of the bearing
Connection	Each component has three lead wires to the terminal box.
Lead Markings	drive-end bearing (D E) – PD1, PD2, PD2 ; non-driven-end bearing (NDE) – PN1, PN2, PN2 If two elements are used for each end of the bearing, the lead of the other element is marked as: drive-end bearing (D E) - PD3, PD4, PD4 ; non-driven-end bearing (NDE) - PN3, PN4, Pn4
Wiring diagram	
Frame sizes	160 to 355

According to temperature measuring elements , K or T type thermocouples can be fitted as an alternative.

Anti-condensation heater

Name	Anti-condensation heater											
Application	Prevent condensation within the motor, which would lead to low insulation resistance											
Temperature resistance of insulating material	≥250°C											
Rated voltage	AC single-phase, 220 - 240V (order schedule)											
Set position	Bound to the winding overhang											
Connection	Two lead wires to the terminal box											
lead Marking	H1 & H2											
Wiring diagram												
Frame	100	112	132	160	180	200	225	250	280	315	355	
Rated wattage of each heating belt	30	30	40	40	50	50	60	60	60	80	110	
Quantity	1	1	1	1	1	1	1	1	1	2	2	

Terminal device of protective equipment

- When the motor is installed with PTC or PTO, its wiring shall be in the main terminal box with eight-post terminal board.
- When the winding or bearing of motor is loaded with PT100, its wiring is arranged in an independent auxiliary terminal box and equipped with terminal bank;
- When the motor is only equipped with winding heating belt, its wiring is on the wall of the main terminal box. (d) When the motor is assembled with heating belt and PT100, the heating belt shall be connected on the wall of the main terminal box, and the PT100 connection shall be located in an independent auxiliary terminal box with terminal bar.
- When the motor is assembled with heating belt and PTC, the heating belt shall be connected on the wall of the main terminal box, and the PTC shall be connected on the eight-column terminal board of the main terminal box.

